

HEWLETT-PACKARD JOURNAL

Cover: A PRECISION DC DIFFERENTIAL VOLTMETER
AND RATIO METER; see page 2

See also: A SYSTEM FOR AUTOMATIC ACQUISITION
OF SEMICONDUCTOR MATERIAL DATA, page 9
A STUDY OF InAs DIFFUSED WITH GOLD, page 16

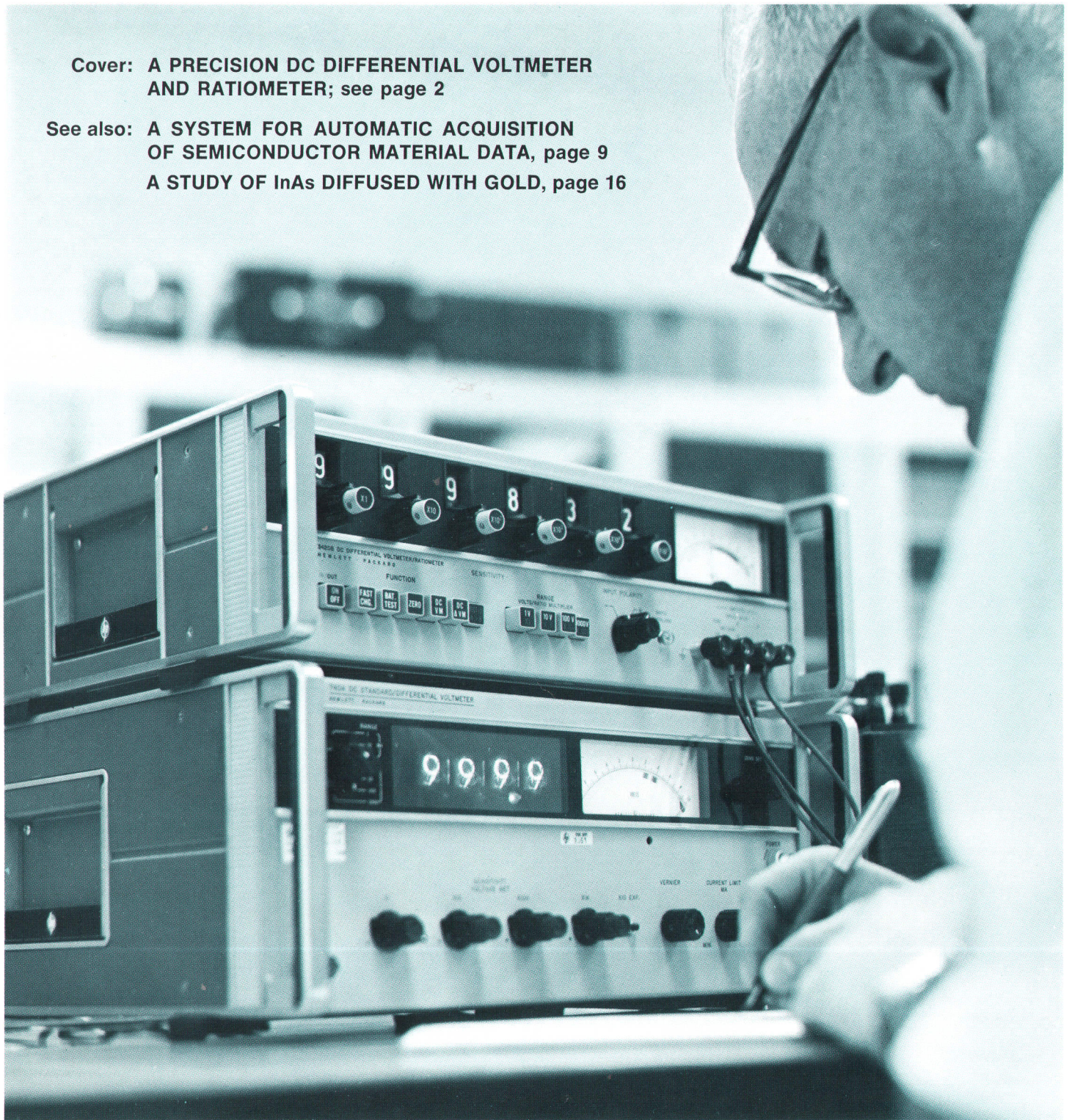

NOVEMBER 1966

A SIMPLIFIED DC DIFFERENTIAL VOLTMETER AND RATIO METER FOR HIGH-PRECISION MEASUREMENTS

An easy-to-use dc differential voltmeter measures dc voltages from 1 microvolt to 1100 volts with a resolution of 0.2 microvolt and with high accuracy. The instrument is also a precision ratiometer for comparing two dc voltages.

MEASUREMENTS OF DC VOLTAGES and of resistance and voltage ratios at accuracies better than about 30 parts per million have been generally performed in standards laboratories by specially trained personnel. Now it is becoming necessary to make measurements at these high accuracies in laboratory and production areas by engineers and test technicians with no special training. Strain gage measurements, line- and load-regulation measurements, noise measurements on solid state circuits such as short-term instability of zener diodes are among the class of situations where high accuracy and instrument reading stability are required.

DC measurement accuracies in excess of 20 ppm can be achieved using the differential method in which the unknown voltage is compared with

a known precision reference voltage. If the precision reference voltage is adjusted to be equal to the unknown, then the unknown can be read to the accuracy of the precision reference.

Differential measurements have been commonly used in standards laboratories where precision sources and precision resistors are available. The setup is somewhat more complex than merely connecting a voltmeter to the unknown, but the accuracy of differential measurements is better than 0.002% compared to the accuracy of direct-measuring analog instruments, which is of the order of 0.5%. Self-contained instruments based on the differential principle have been available which offer better accuracies than direct measurement means, but they are complicated to use.

Now, an instrument (Fig. 1) with the capability of a dc differential voltmeter and the ability to measure voltage ratios has been designed to give an accuracy of $\pm 0.002\%$ of the reading (± 20 ppm). The voltmeter is simple to operate and has been designed in both a power-line-operated version and a battery-operated version operating from self-contained rechargeable nickel-cadmium batteries. This capability to operate from a self-contained supply is important when measuring voltages with very high ac or dc common mode. Because the instrument is isolated from the line, the common mode voltages do not influence the reading. However, the instrument has good common mode rejection when operated on the power line.

In the dc differential voltmeter mode, the instrument measures dc voltages up to ± 1100 volts in four ranges of ± 1 , 10, 100 and 1000. Voltage resolution is 0.2 microvolt, or 0.2 ppm of range.

VOLTAGE MEASUREMENT

The basic components of the instrument include (Fig. 2) an accurate and stable voltage source, a precision resistance divider and a low-drift, high-sensitivity null detection meter.

An input voltage applied to the input terminals is applied directly to the decade dividers on the 1- and 10-volt ranges. On the 100- and 1,000-volt ranges, the range attenuator reduces the voltage to the 1-volt

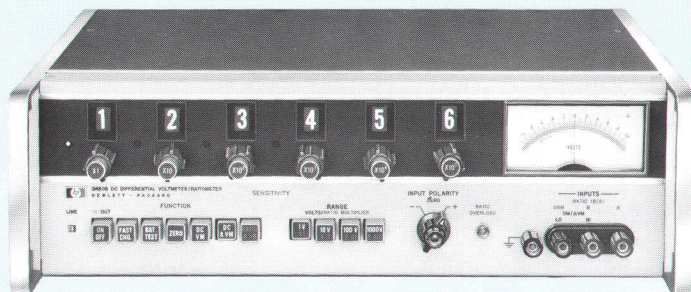

Fig. 1. The *-hp-* Model 3420A/B Differential Voltmeter/Ratiometer is a precision solid-state instrument capable of measuring dc voltages from below 1 μ V to 1100 volts at resolutions of 0.2 ppm and accuracies of 20 ppm over much of this range. Measurements can also be made of resistance and voltage ratios in four ranges from 1 to 0.001 to the same accuracy. The controls are color coded and simplified so that readings can be made rapidly without the necessity of operating a complexity of controls.

level for comparison to the precision source through the dividers.

The unknown voltage is compared to the voltage derived from a very high accuracy 11-volt reference source and the setting of the six decade dividers. The difference is indicated on the null meter. A complete null is reached when the six decades have been nulled to the highest sensitivity.

Range of the instrument as a dc differential voltmeter is ± 1 to ± 1000 volts with a 10% overranging available on all ranges. DC voltage measurements on the 1- and 10-volt ranges are performed by the potentiometric technique, that is, by comparing the input voltage to a known internal voltage. On the 100- and 1000-volt ranges, the input voltage is scaled to the 1-volt level by a precision 10-megohm $\pm 0.05\%$ resistance divider.

Resistance and voltage ratios of 0.000 000 001:1 to 0.999 999:1 can be measured. Four ranges provide the same accuracy and resolution as in the differential voltmeter mode.

Input impedance at the null is about 10^{12} ohms, which is considerably higher than the impedance presented to the source by most measuring instruments. This high impedance does not load the source. For example, a 500-ohm standard cell will drop 50 microvolts when looking into a 10-megohm impedance, equivalent to an error of about 50 ppm. An input impedance of 10^{12} ohms has an effect on the cell voltage of less than one part per billion.

A recorder output drives recorders with 0 to 1 volt at 1 mA. A zero button is provided for quick zero check. There is no need to disconnect voltages or return the decades to zero.

INPUT RESISTANCE

Input resistance approaches infinity as the decade setting approaches the value of the unknown voltage (approaching the null), Fig. 3. The only limitation on the input resist-

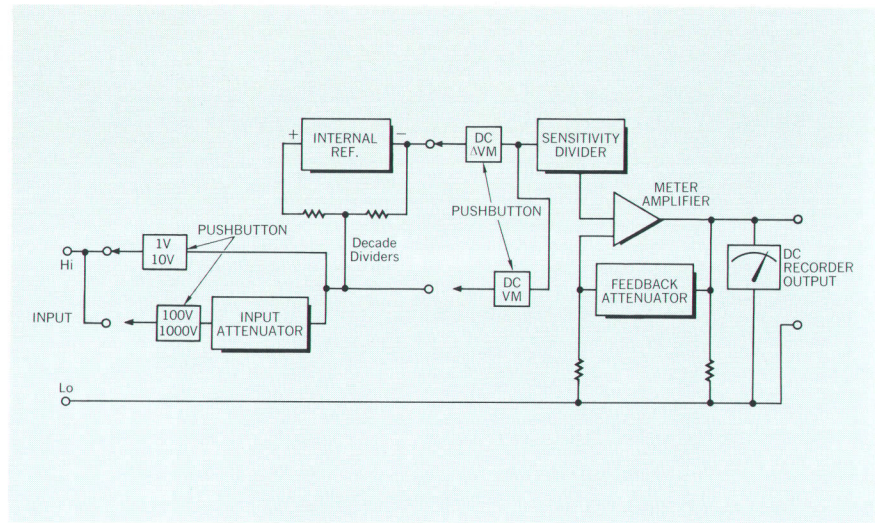

Fig. 2. In the differential voltmeter mode, the floating voltage-reference supply is used to drive the precision decade dividers. On the 1-volt and 10-volt ranges the input voltage is nulled directly against the 6-digit dividers. On the 100-volt and 1K-volt ranges the input voltage is divided to the 1-volt level and then nulled with the decades. The instrument can also be used as a dc voltmeter with the reference disconnected.

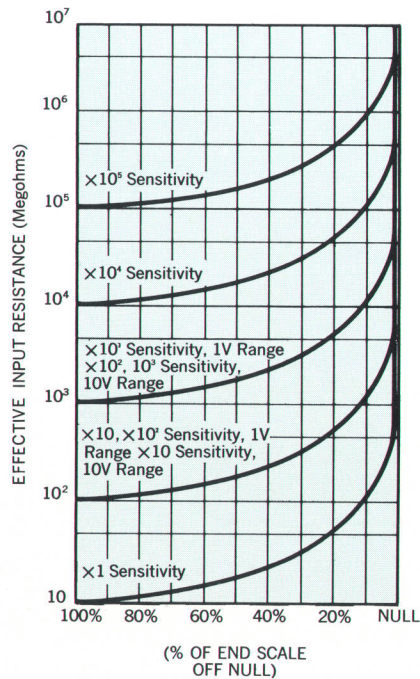

Fig. 3. Input resistance to the -hp- Model 3420A/B approaches infinity as the null is approached. Input resistance at the null is determined only by leakage resistance of switches and wiring.

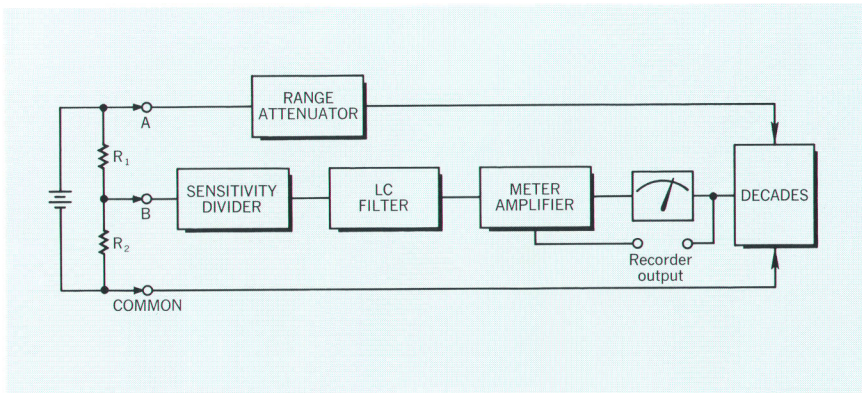

Fig. 4. In the ratiometer mode of operation, the *hp-Model 3420A/B* acts as a modified Wheatstone bridge to make voltage and resistance divider measurements. The range attenuator and decade divider make up one side of the bridge and the meter amplifier acts as the null detector. The connections from A to COMMON and B to COMMON are the other side of the bridge.

ance is the leakage resistance of the voltmeter before the decade dividers. Special materials used in the switches and wiring keep the leakage resistance above 10^{12} ohms.

RATIOMETER MODE

Often the absolute value of dc voltage is of little interest. In measurements involving resistor-divider action, potentiometer linearity, power supply calibration and comparison of voltage levels, the real point of importance is the ratio of

one voltage to some other voltage, such as in a voltage divider. Where the source voltage is stable with time, the ratio could be determined by measuring each voltage separately and calculating the result. But if the source voltage has a high drift rate with time, it is not possible to determine the ratio with high resolution. However, if one voltage from the divider is divided until it equals the second, the ratio can be read instantaneously. All the components necessary to perform this type of

measurement with high accuracy are present in the new differential voltmeter/ratiometer.

The ratiometer offers quick checking of range switch components and voltage dividers, where the absolute value of individual components is of little interest. For resistance-ratio measurements, the voltage used across the two resistors, Fig. 4, need not be accurate, stable, nor of any particular value. Basically, one of the input voltages replaces the reference supply used in the differential voltmeter mode.

The higher of the two input voltages is used as the reference and is fed to the series combination of the range stick and decade divider where it is divided to the same value as the lower input voltage. This condition of equality is monitored by the null meter. In this measurement technique, the two input voltages must have a common ground and be of the same polarity with respect to that ground.

The null meter can be calibrated to read directly in steps correlated with the decade readout when making resistance ratio measurements. To do this, it is necessary to drive the decade (the high input voltage V_A) with an accurate voltage of 1 volt on the $\times 1$ range, or 20 dB more for each increasing range. If this level changes after calibration, the null meter calibration changes but not the ability to null the instrument. Drive voltage should be chosen to calibrate the meter on the range being used.

The ability to select ratio ranges has the advantage that accuracy specifications for the measurement can be applied as a percent of range. Since the highest accuracy is in the first two decades, it is advantageous to be able to make the reading on these decades. Thus, for low-ratio numbers, the instrument can be set to keep the reading on the first two decades.

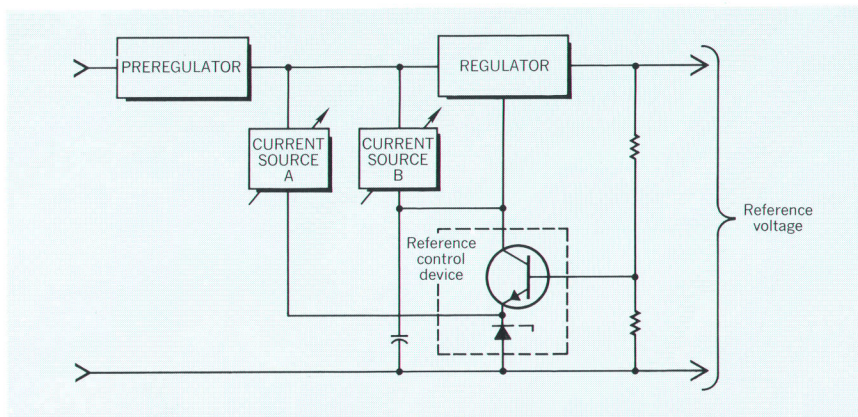

Fig. 5. The 11-volt precision reference supply is a combination of a Zener reference diode and a control transistor. The control transistor generates the correction signal to keep the output at its specified level.

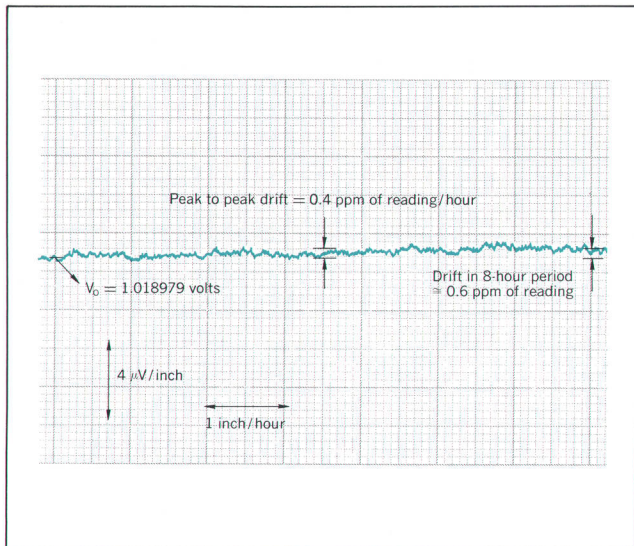

Fig. 6. Short-term stability charts show a peak-to-peak drift of less than 0.4 ppm of reading per hour while on battery operation measuring an unsaturated standard cell.

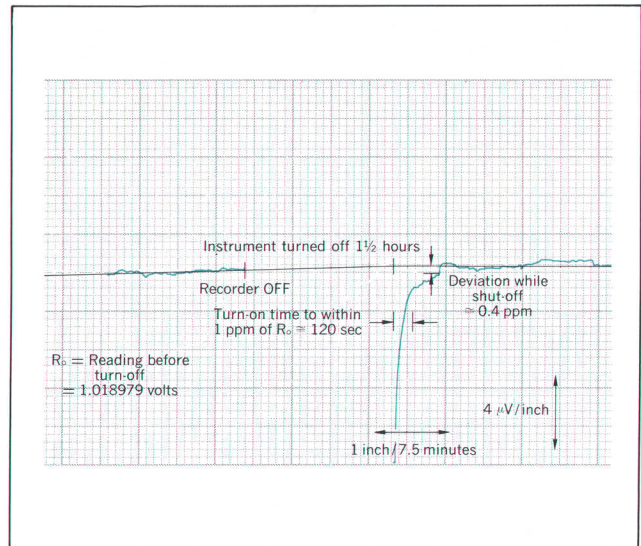

Fig. 7. After being turned off for 1½ hours, the *-hp-* Model 3420A/B returned to within 1 ppm of its original reading within two minutes after being turned back on.

CIRCUIT CONSIDERATIONS

To achieve high accuracy in the instrument, the reference voltage source must be carefully designed, the decade dividers must follow a linear relationship, and the zero drift of the null meter must be low.

In this instrument the precision 11-volt reference is derived from a zener diode reference supply (Fig. 5). Since the instrument operates on battery power, an oven for the zener diode was not used. To eliminate the effect of environmental change on the reference voltage, a technique was developed to adjust the dc temperature coefficient of the 11-volt reference to below 1 ppm per degree C, over the range +20° to 30°C. Over the complete temperature range +10° to 40°C, the temperature coefficient is below 2 ppm per degree C.

Another factor in assuring high stability is the ability of the total circuit to remain stable from full battery voltage of 31 volts to a minimum of 24 volts. Over this range, the 11-volt reference changes less than 1 part per million.

Long-term stability is controlled by the reference amplifier and a set

of precision resistors. The reference amplifier consists of a micro-miniature planar transistor and an alloy diffused breakdown diode. The long-term stability of the supply is greater than 15 ppm/6 weeks.

Excellent short-term stability of voltage is insured by intimate physical contact of the components in the reference amplifier and by using a thermal lag box over this reference subassembly. Short-term stability is shown in Fig. 6, taken with the instrument on battery operation in a standards lab environment.

An advantage of ovenless operation is fast turn-on. In Fig. 7, the chart shows a turn-on time to within 10 ppm of the previous reading in less than 20 seconds and to within 1 ppm in less than 2 minutes.

Precision resistors used in the decade dividers enhance the accuracy of the instrument. Their value in each decade does not differ by a ratio of more than four to one. Therefore, it is possible to wind the resistors with the same size wire from the same spool to insure temperature tracking to within 1 ppm per degree C. To facilitate recalibration, the first and second decade of

the decade dividers are adjustable.

Each of the six decades of the decade divider is binary coded¹, that is, resistor values are chosen so that by appropriate switching, division ratios of 1 through 10 in equal increments are available using four resistors instead of eleven. The first decade has a 10% overrange capability to aid in measuring voltages that occur slightly above full scale. Use of a six-digit divider means 1 ppm of full scale resolution on the decade with no last digit ambiguity.

The 10-megohm ±0.05% input range attenuator used on the 100-volt and 1000-volt ranges is composed of four adjustable *-hp-* wirewound resistors with ratio-matched temperature coefficient to 1.5 ppm per degree C. To eliminate self-heating errors in the 10-megohm resistor, its absolute temperature coefficient is held to below 2 ppm per degree C.

Resolution of the instrument is controlled by the sensitivity, noise, and zero stability of the null detector. To achieve low drifts at high sensitivity, a photo-chopper stabil-

¹ Described in an article by Robert E. Watson, 'A Combined DC Voltage Standard and Differential Voltmeter for Precision Calibration Work,' *Hewlett-Packard Journal*, Vol. 16, No. 9, May 1965.

ized meter amplifier is used (Fig. 8). The maximum sensitivity of the null detector is $10\ \mu\text{V}$ full scale. The $3\ \sigma$ noise limit,² is $0.4\ \mu\text{V}$, or less than $0.4\ \mu\text{V}$ about 99% of the time, or about $0.13\ \mu\text{V}$ rms.

To achieve the $10\ \mu\text{V}$ maximum sensitivity and supply a 1-volt recorder output, a total gain of 10^5 or 100 dB from input to recorder out-

² A discussion of specifying noise is included in the article by Charles D. Platz, 'A Sensitive, Wide Range DC Null Voltmeter with an Internal Bucking Supply for Zero Loading Error,' *Hewlett-Packard Journal*, Vol. 17, No. 7, March 1966.

put is used. To insure excellent gain accuracy of the null detector under changing environmental conditions, an excess of 50 dB of negative feedback is used.

Ranging in the null detector is done by a combination of pre-attenuation of the signal and gain changes in the amplifier closed loop gain. Filtering of the ac normal mode noise is accomplished by a double LC filter which gives excel-

lent ac rejection and fast recovery from overload.

The instrument is protected throughout against accidental overload. A 1 kV dc signal will cause no damage even on the $10\ \mu\text{V}$ sensitivity, a 160 dB overload.

The combination of high stability in the voltage reference supply, high resolution and zero stability in the null detector and six decade divider gives a useful sensitivity of 0.2 ppm of range on all four ranges.

USING THE DC DIFFERENTIAL VOLTMETER/RATIOMETER TO CONSTRUCT A 100:1 PRECISION DIVIDER

The ratiometer has 0.2 ppm of range resolution on all ranges. With this high resolution and the high stability of better than 1 ppm per hour, the instrument can be used to match precision resistance dividers with accuracies approaching $\frac{1}{2}$ ppm. Examine the problem of constructing a 100-to-1 divider from a set of ten 1000-ohm resistors and one 90,000-ohm resistor. The first step would be to adjust two of the 1000-ohm resistors to an exact 1-to-1 or a ratio of one-half (Fig. 1). To insure that the ratio is exactly $\frac{1}{2}$ and to remove errors, the voltage to the combination of R_1 and R_2 is reversed and an identical deflection noted. This procedure affirms that $R_1 = R_2$ in the measurement configuration shown. The instrument should then be set to null at this reading and then used to compare all the 1000-ohm resistors to make them equal. It is important to note that the 1000-ohm resistors may not be exactly 1000 ohms, but they are all equal.

By using this set of ten identical resistors, a 10-to-1 divider may be set up. On the $\times 0.1$ range, the ratio can be read to within 0.2 ppm resolution. The accuracy is dependent only on the precision matching of the 1000-ohm resistors. This reading may now be used to match the 90,000-ohm to the 10,000-ohm total set of resistors. The total divider (Fig. 2) is now ratio-matched to within a few tenths of a ppm. Its dividing accuracy can be checked by several different independent methods, such as comparing IR drops across each set of 10:1 dividers.

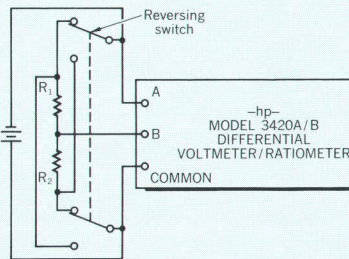

Figure 1

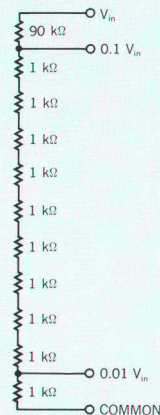

Figure 2

VOLTAGE LIMITS

When making voltage ratio measurements, some care must be taken to avoid applying too high a voltage to the decade dividers. For example, on the $\times 1$ range the accuracy specification is for any voltage between 1 and 10 volts. At voltages between 10 volts and 90 volts on the $\times 1$ range the instrument may still be used but the accuracy is reduced because of self heating of the decade resistors. This self-heating error follows a square-law function. At 50 volts on the $\times 1$ range the self-heating error is approximately 18 ppm of reading, while at 90 volts the error is 58 ppm of reading. On the $\times .1$ range the error at 70 volts is less than 9 ppm of reading. The maximum voltage on the $\times .01$ range is 500 volts and on the $\times .001$ range it is 1200 volts. The input voltage "A to Common" to the instrument on the $\times 1$ and $\times .1$ ranges is limited by an internal protection circuit to approximately 100 volts. If this level is exceeded, large currents will be drawn from the source. This limitation means that ratios close to 1:1 of high voltages cannot be measured directly.

CALIBRATION

All components that influence accuracy are adjustable. The resolution of these adjustments is better than 1 ppm of the component value. A printed circuit calibration board for the binary coded decades is provided. Decade calibration is done on

a ratio-matching basis and the linearity of the completed assembly is better than 8 ppm of reading. The 1-volt and 10-volt ranges can be calibrated by measuring standard cells. The input range attenuator can be calibrated by measuring ratios near the full scale value of each range.

MECHANICAL DESIGN

On the front panel, the pushbuttons and switches are color-coded for ease of identification. The decade divider readout consists of ½-inch white numbers on a black background. Off-axis viewing of these numbers is possible to greater than 40 degrees. Input terminals are located to prevent danger of shock when measuring high voltages.

ACKNOWLEDGMENTS

The 3420A/B was developed at the Loveland Division laboratories under the group leadership of Robert Watson. Product design was by

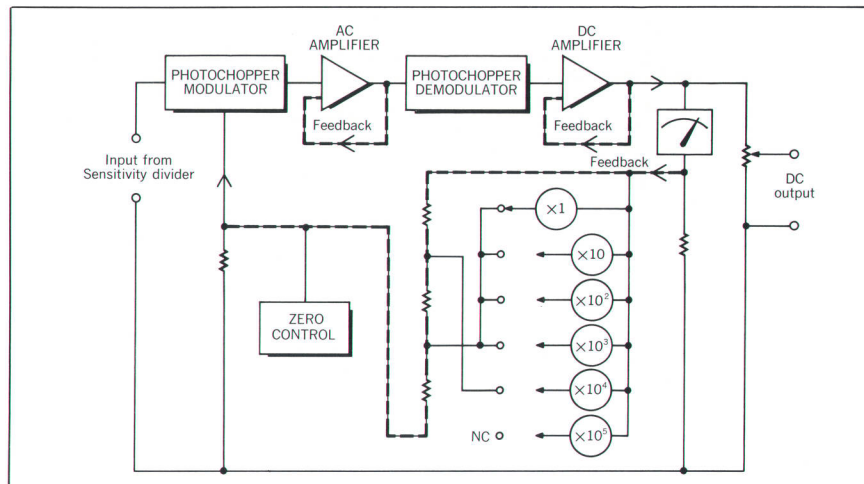

Fig. 8. The meter amplifier is a high-gain, chopper stabilized amplifier with a large amount of negative feedback. Its effective input impedance is high, and it draws very little current from the sensitivity divider.

Larry Carlson and electronic design by the undersigned. Contribution in the design of the precision resistors by Russell Meston is gratefully acknowledged. Also, the ideas and

suggestions of Marco Negrete and Donald F. Schulz were valuable through the development.

—Lawrence J. Lopp, Jr.

DESIGN LEADERS

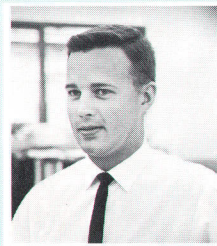

LARRY L. CARLSON

Larry Carlson started with Hewlett-Packard, Loveland Division, part time while attending Colorado State University. After receiving his Bachelor of Science in Electrical Engineering in June, 1962, he joined the engineering staff full time in Production Engineering where he had engineering responsibility for several dc voltmeters and dc power supplies. Larry transferred to the Research and Development Laboratory in January, 1965, as a product engineer. Larry is a member of IEEE and is presently attending Colorado State University on the -hp- Honors Cooperative Program working on his MS in EE.

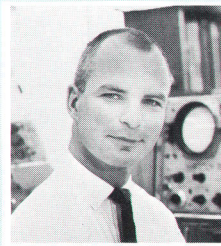

LAWRENCE J. LOPP, JR.

Larry Lopp joined the Hewlett-Packard Loveland Division in July, 1964, after receiving his Bachelor of Electrical Engineering from the University of Minnesota. During college he worked on a research project in solid-state device noise. He started work in the Research and Development Lab and did work in high-stability, high-temperature coefficient, voltage reference system. He was project leader and did the electronic design of the 3420A/B. In August, 1966, Larry transferred to the integrated circuit activity as development engineer at Loveland. He is a member of the Audio Engineering Society.



ROBERT E. WATSON

Bob Watson is a group leader in the Hewlett-Packard Loveland Laboratories with responsibility for dc differential voltmeters, low-level dc voltmeters and dc standards. He was also responsible for the electrical design of the -hp- Model 735A DC Transfer Standard. Bob joined Hewlett-Packard in 1961 following two years work in atmospheric and ionospheric research at a university-affiliated laboratory. He holds both a BSEE and an MSEE from the University of Utah, and he is a member of Eta Kappa Nu, Tau Beta Pi and Sigma Xi.

SPECIFICATIONS
-hp-
MODEL 3420A/B
DC DIFFERENTIAL
VOLTMETER/RATIOMETER

DC DIFFERENTIAL VOLTMETER

RANGES: ± 1 , ± 10 , ± 100 and ± 1000 volts with up to 10% overranging available on all ranges.

RESOLUTION: Six dials provide 1 ppm (parts per million) of range. Null meter provides full scale indication of 10 ppm of range with maximum resolution of 0.2 ppm on all ranges.

PERFORMANCE RATING:

ACCURACY: $\pm(0.002\%$ of reading $+0.0002\%$ of range) at $23^\circ\text{C} \pm 1^\circ\text{C}$, less than 70% R.H. (relative humidity).

STABILITY: Rated accuracy is met after a 1 hour warm-up period, with a 30-day calibration cycle. $\pm 0.005\%$ accuracy within 30 seconds of turn-on.

Short Term: 1 ppm/hour, 5 ppm/day exclusive of zero drift.

Zero Stability: 0.5 ppm per day of range.

TEMPERATURE COEFFICIENT: $T_{ref} = 23^\circ\text{C}$

		10° - 20°C and 20° - 30°C	30° - 40°C
11 volt Reference		$\pm 1.0 \text{ ppm}/^\circ\text{C} \pm 2.0 \text{ ppm}/^\circ\text{C}$	
Total instrument exclusive of zero drift		$\pm 4 \text{ ppm}/^\circ\text{C}$ of reading	$\pm 5 \text{ ppm}/^\circ\text{C}$ of reading

Zero drift $< 0.25 \text{ ppm of range}/^\circ\text{C}$, 10° to 40°C .

OFF NULL ACCURACY: $\pm 3\%$ of sensitivity setting.

LINE REGULATION: 1 ppm for 10% line voltage change.

INPUT CHARACTERISTICS:

ΔVM Range		Input Resistance
1 V	10 V	Infinite ($> 10^{11}\Omega$ @ $< 70\%$ R.H.) at null
100 V	1000 V	$10\text{M}\Omega \pm 0.05\%$

Null Detector Range	Input Resistance
$10 \mu\text{V} - 10 \text{ mV}$	$1\text{M}\Omega$
$100 \text{ mV} - 10 \text{ V}$	$10\text{M}\Omega$

Input is open-circuit except when a VM, ΔVM , or Ratio button is depressed.

SUPERIMPOSED AC REJECTION: AC voltages (60 Hz and above) whose rms value is equal to the dc input voltage causes $< 0.0008\%$ error in the reading. Maximum ac input: 25 V rms on the 1 V range, and 200 V on all other ranges.

ISOLATION PARAMETERS:

INPUT: Floating binding posts on the front panel may be operated up to $\pm 1000 \text{ Vdc}$ with respect to chassis ground (700 Volts rms).

BATTERY OPERATION (3420B): Provides complete isolation from external circuits.

LINE OPERATION (3420A/B): Common mode rejection is the ratio of common mode signal to resultant error in readout, with 1 k Ω unbalance.

At dc: $> 140 \text{ dB}$ on all ranges at less than 70% R.H.

At 60 Hz and above: $> 150 \text{ dB}$ on all ranges.

OUTPUT SIGNALS: Recorder output adjustable from 0 to $\pm 1 \text{ Vdc}$, 1 mA maximum current. Output is proportional to meter deflection. (Low side of recorder common to low side of input.)

OPERATION FEATURES:

DC VOLTMETER OPERATION:

Ranges: 10 μV to 1 kV in nine decade ranges.

Accuracy: $\pm 3\%$ of end scale.

Input Resistance: 10 μV to 10 mV range: 1 M Ω ; 100 mV to 1000 V range: 10 M Ω .

Input Zero: A pushbutton switch is provided to automatically disconnect the input terminal and short the amplifier. Nominal zero adjustment range: $\pm 15 \text{ ppm}$ of range.

Polarity Selection: Switch is provided to allow measurement of positive or negative voltage with respect to circuit common.

EXTREME OPERATING CONDITIONS:

OVERLOAD PROTECTION: $\pm 1000 \text{ Vdc}$ may be applied on any range or sensitivity for up to 1 minute without damaging the instrument.

OVERLOAD RECOVERY: Meter indicates within 3 sec after removing 10^6 overload factor.

DC RATIOMETER

RANGES: $\times 1$, $\times 1.1$, $\times 0.1$, $\times 0.01$ with six digit in-line readout.

RESOLUTION: Same as ΔVM .

PERFORMANCE RATING:*

ACCURACY: $\pm(0.002\%$ of reading $+0.0004\%$ of highest decade setting) at $23^\circ\text{C} \pm 1^\circ\text{C}$, less than 70% relative humidity.

STABILITY: Rated accuracy is met after a 30-second warm-up period, with a 60-day calibration cycle.

Short Term: 0.5 ppm/hour, exclusive of zero drift.

Zero Stability: 0.5 ppm of range/day.

TEMPERATURE COEFFICIENT: $\times 1$ range: 1 ppm/ $^\circ\text{C}$, $\times 0.01$ range and above: 5 ppm/ $^\circ\text{C}$, to 40°C .

INPUT CHARACTERISTICS:

INPUT: 3 terminals: A, B, common.

RATIO = B to common
A to common

With $A > B$ and same polarity.

INPUT VOLTAGE RATIO: Null meter calibrated to read directly in ppm of range for lowest A to Common calibration voltage indicated in table below.

RANGE	Calibrated A to Common	Maximum A to Common
$\times 1$	1 - 10 Vdc	50 V
$\times 1.1$	10 - 70 Vdc	90 V
$\times 0.1$	100 - 500 Vdc	500 V
$\times 0.01$	1000 Vdc	1200 V

* For calibrated A to Common voltage shown in table.

INPUT RESISTANCE:

Terminal B to Common: Infinite at null ($> 10^{10}\Omega$ @ 70% R.H.).

Terminal A to Common:

Range	Input Resistance
$\times 1$	10K Ω
$\times 1.1$	100K Ω
$\times 0.1$	1M Ω
$\times 0.01$	10M Ω

SUPERIMPOSED AC REJECTION: 60 Hz signals equal to 100% of A to common DC affects reading less than 2 ppm of meter reading.

ISOLATION PARAMETERS:

Same performance as for ΔVM .

OUTPUT SIGNAL: Recorder output has the same capability as for the ΔVM , except recorder must be isolated from ground by $10^{10}\Omega$.

EXTREME OPERATING CONDITIONS:

OVERLOAD PROTECTION: Input voltage A to Common automatically limited to 100 Vdc on $\times 1$ and $\times 1.1$ range with front panel overload indication. Maximum input current is 100 mA for 1 minute on these ranges. Maximum input 1100 Vdc on $\times 0.1$ and $\times 0.01$ ranges.

OVERLOAD RECOVERY: Same as ΔVM .

GENERAL

INPUT POWER: 3420A/B: 115 or 230 volts, $\pm 10\%$, 50 to 1 kHz. Approximately 2 watts.

3420B: Battery/Line Operation Rechargeable batteries (8 furnished). 30 hours operation per recharge.

Instrument may be operated during normal recharge from ac line. Provision is made for testing the battery condition and selecting a fast (15 hour) charging rate. Input for battery charging 115 or 230 Volts, $\pm 10\%$, 50 to 1000 Hz. 3 watts.

WEIGHT: Net: 21 lbs. (9,45 kg); Shipping: 24 lbs. (10,8 kg).

PRICE: 3420A \$1175 3420B \$1300

MANUFACTURING DIVISION:

-hp- Loveland Division
Box 301, Loveland, Colorado 80537

Prices f.o.b. factory
Data subject to change without notice

ADAC—AN AUTOMATIC SYSTEM FOR MEASURING HALL EFFECT IN SEMICONDUCTORS

One of the barriers to detailed materials analysis has been the large effort involved in data acquisition and reduction. This has been greatly reduced in the -hp- laboratories by a system called ADAC. New information on the electronic transport properties of InAs has been one of the first benefits of the system.

PHYSICAL PROPERTIES OF SEMICONDUCTORS depend upon the composition and structure of the material. A complete understanding of these properties enables a researcher to apply the material in a practical device or system.

Because of the mass of data required for a complete materials analysis, the determination of parameters over a wide environmental range is time-consuming. Besides the time required for taking the data, a great deal of time is also required for reducing and plotting the data. This limits the amount of information generally available to the device-oriented engineer from a materials supplier or from his own laboratory. Consequently, the greater the amount of information that can be furnished on a given material, the greater will be the savings of time and money in development or research.

Two fundamental properties govern electronic transport phenomena in semiconductor materials: carrier concentration and carrier mobility. From a knowledge of these, a large number of useful properties are derived.

An important part of any semiconductor material study is to carry out a sufficiently large number of measurements to determine carrier mobility and concentration under varying conditions. Then the data must be reduced and plotted, and the results analyzed to describe the materials.

Of several galvanomagnetic effects observed in metals and semiconduc-

tors, the Hall effect is of perhaps greatest interest as a research tool. Its importance cannot be overestimated. It provided the first verification of electrical conductivity by positive holes in semiconductors. Without it, detailed analyses and predictions of current flow under a great variety of external stimuli and internal physical and chemical conditions would be impossible.

In investigating electrical properties of a semiconductor, a study of

the temperature dependence of the Hall effect will give fundamental information on scattering and ionization energies of various impurities. The sign of the Hall effect denotes the type of predominant carriers (holes or electrons) contributed by these various impurities. For the most common case in which one type of carrier is predominant, the magnitude of the Hall effect gives the concentration of charge carriers. When combined with con-

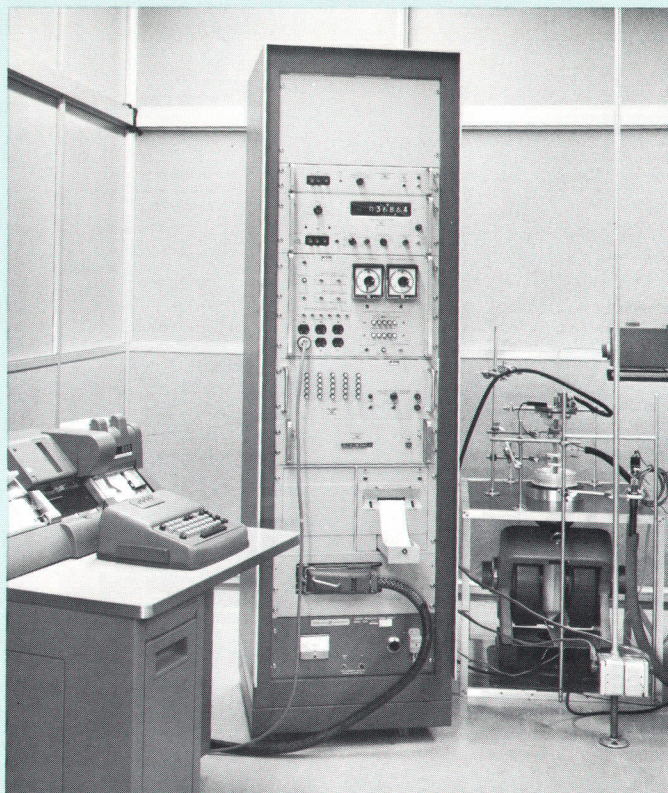

Fig. 1. The complete ADAC system consists of the controller and data-acquisition equipment in the rack and the dewar and magnet, shown at the right. This relatively compact system can be supplemented by various data-recording means, such as the card punch equipment, left.

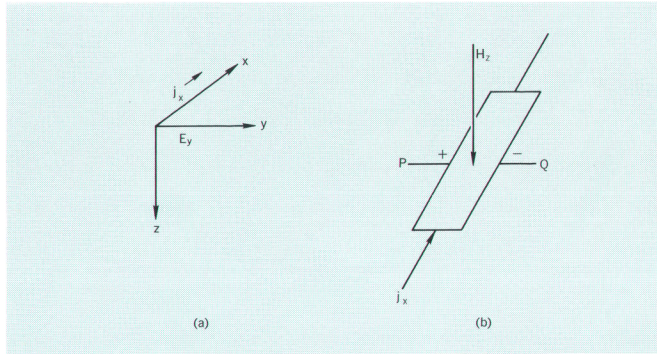

Fig. 2. Measurement of the Hall effect. Vectors (a) show the directions of current, magnetic induction and the Hall field for negative electrons. The strip of conducting material (b) has its edges parallel to the x and y direction.

ductivity measurements, the Hall effect permits the determination of the mobility (drift velocity per unit field) of the carriers. A knowledge of the mobility and its temperature variation is required to determine the predominant scattering mechanisms (lattice, ionic, or neutral impurity scattering, etc.). These scatter mechanisms are intimately connected with chemical purity and structural perfection.

HALL EFFECT

The Hall effect is a manifestation of the Lorentz force, the force exerted on a moving charge by a magnetic field. When a magnetic field is applied at right angles to the direction of current flowing in a conductor, an electric field is set up in a direction perpendicular to both the direction of the current and of the magnetic field, in opposition to the Lorentz force. If a coordinate system with three mutually perpendicular axes is set up, Fig. 2(a), the Hall field E_y is given by

$$E_y = R j_x B_z$$

Where R is the Hall coefficient, j_x is the current density in the x direction, and B_z is the magnetic induction along the z axis. Now it can be shown that the Hall coefficient is (in the one-carrier case) within a factor close to unity, given by

$$R = \frac{1}{ne}$$

where n is the density of charge car-

riers and e is the electronic charge. The sign of e (i.e., whether the charge carriers are holes or electrons) determines the direction of E_y and the sign of the Hall coefficient. The sign of e is taken as negative for electrons, giving a negative Hall coefficient.

The electrical conductivity σ is defined by

$$\sigma = \frac{j_x}{E_x}$$

or

$$\sigma = ne \frac{V_x}{E_x} = ne\mu$$

where μ , the mobility, is the drift velocity of a carrier per unit electric field. The mobility then is given by

$$\mu = R \sigma.$$

The mobility as deduced from the measured Hall coefficient is, strictly speaking, the Hall mobility and can differ from the drift mobility by a factor very nearly unity. For most purposes, particularly in extrinsic semiconductors, this distinction is unimportant and can be neglected.*

Magnetic field and temperature are only two of the variables needed for electronic transport characterization in solids. Hydrostatic or uniaxial pressures are often applied, and the material is sometimes subjected to radiation fluxes to establish relationships which aid in describing the material. In summary, the carrier concentration and the car-

* A detailed discussion of the Hall effect for the case of more than one type of carrier can be found in another part of this article.

rier mobility depend upon electric field, temperature, magnetic field, radiation flux, pressure and chemical composition.

DATA ACQUISITION

To make a valid Hall effect measurement, several things are required. The voltage measurements are usually dc voltages in the millivolt to volt range. A high degree of stability (0.01% full scale per day) and resolution (0.01% of full scale) are necessary, and because of the high resistance of some of the experimental samples, a very high-input impedance, at least 10^{10} ohms, digital voltmeter is required.

Several effects can cause serious errors in the measurement of the Hall voltages. In Fig. 2(b), if points P and Q are not exactly opposite each other, there will be a misalignment voltage which will add to or subtract from the Hall voltage. The effect of this misalignment voltage is eliminated by measuring the voltage from P to Q in the absence of a magnetic field and subtracting this voltage from the value measured in the magnetic field and with exactly the same current flowing. A better way is to reverse the current (which reverses the misalignment voltage but not the Hall voltage) and average the two values of measured voltage V_{PQ} , giving the true Hall voltage. Similarly, if the magnetic field is reversed (this reverses the Hall voltage but not the misalignment voltage) one-half the difference between the measured voltages is equal to the true Hall voltage. In practice it is necessary to take the average of four measurements (with all four combinations of current and magnetic field) to eliminate disturbing thermomagnetic and thermoelectric effects.* Certain second-order effects of this type (Nernst-Ettingshausen and Righi-Leduc effects) are minimized by having the sample well heat-sinked to eliminate tempera-

* A detailed discussion of the data reduction of this system can be found in another part of this article.

ANALYSIS OF SOLIDS WITH MORE THAN ONE TYPE OF CARRIER

In the most general case, the Hall effect gives a measure of the contribution of *all* mobile charge carriers to the conduction process. These carriers can be holes and electrons existing simultaneously. In a material such as GaAs, it is possible to have two varieties of electrons ("light" and "heavy" electrons) at the same time. In ZnAs₂, there are known two varieties of electrons and two varieties of holes that can coexist. In general, the Hall coefficient and conductivity are given by

$$R = \frac{1}{e} \frac{n_1\mu_1^2 + n_2\mu_2^2 + \dots + n_t\mu_t^2}{(n_1\mu_1 + n_2\mu_2 + \dots + n_t\mu_t)^2}$$

$$\text{and } \sigma = e(n_1\mu_1 + n_2\mu_2 + \dots + n_t\mu_t)$$

where *t* is the number of distinct populations of charge carriers.

From these equations it is apparent that the determination of *R* and σ under only one set of environmental conditions will not allow us to separate the contributions of the different *n*'s and their corresponding μ 's. For this reason it is necessary to measure *R* and σ as a function of temperature and then fit the resulting curves to calculations based on models of two or more carrier

populations contributing to the conductivity. An aid in this correlation is the relationship

$$\frac{1}{\mu} = \frac{1}{\mu_1} + \frac{1}{\mu_2} + \dots + \frac{1}{\mu_t}$$

where $\mu_1 = \alpha_1 T^{\beta_1}$, $\mu_2 = \alpha_2 T^{\beta_2}$ etc.

The temperature dependences β are obtained from the slope of a log-log plot of mobility versus temperature. These values of β can be correlated with calculations for mobility variation based on specific scattering laws. For example, values of β are +3/2 for ionized impurity scattering, zero for neutral impurity scattering, -1/2 for high-temperature optical phonon lattice scattering, and -3/2 for acoustical phonon lattice scattering.

The case of the temperature dependence of carrier concentrations is similar:

$$n = N_1 \exp \frac{-E_1}{kT} + N_2 \exp \frac{-E_2}{kT} + \dots + N_t \exp \frac{-E_t}{kT}$$

The values of *N*₁, *N*₂, . . . and *N*_{*t*} in this equation are the densities of states in the conduction band or valence band

for the various populations of electrons and holes, and their slight temperature dependences can usually be ignored. The values *E*₁, *E*₂, . . . and *E*_{*t*} are the activation energies of the various kinds of carriers, measured with respect to the appropriate reference energy. A knowledge of these energies is of great importance to the understanding of the material. These values of activation energy can be obtained graphically by evaluating the slope of a semilogarithmic plot of carrier density versus reciprocal temperature.

The most general case of semiconductors represent many degrees of complexity: (1) there are many types of mobile charge carriers; (2) there are many types of defects having varying amounts of ionization energies and scattering cross sections; and (3) there is sometimes even more than one ionization state. The collection, reduction and analysis of data in such cases is so laborious that it is seldom attempted. The existence and availability of ADAC opens up the possibility of investigating such materials.

ture gradients.

The elimination of the previously described errors and the improvement in the accuracy of the measurements by averaging are accomplished by making and recording the measurements in a programmed sequence. If the time interval between measurements is as short as possible, the errors due to thermal drift will be minimized.

AUTOMATIC DATA ACQUISITION

To simplify the task of acquiring the mass of data needed to analyze semiconductor materials, an Automatic Data Acquisition Controller (ADAC), has been designed and is in use at the -hp- Laboratories. ADAC is a programmable master control unit for measuring conductivity and Hall effect, and for recording the ensuing data. It uses an -hp- 2010 data acquisition system, an

electromagnet, a current source, a light source for photo-Hall and photoconductivity measurements, and a temperature controller as slave units (Fig. 1). This programmed stimulation, measuring and recording system is designed to (1) sequentially set a combination of external conditions to which the data-supplying sample is subjected, (2) move sequentially through a programmed measuring and recording Scan Position channel matrix, (3) provide identification of the incoming data for the recording units, (4) move through this environment-setting, measuring and recording sequence at uniform time or temperature intervals, and (5) shut itself off at the end of the experiment.

REFERENCE

R. H. A. Carter, D. J. Howarth and D. H. Putley, 'A Digital Recording System for Measuring the Electrical Properties of Semiconductors,' *Journal of Scientific Instruments*, Vol. 35, No. 3, pp. 115-116, March 1958.

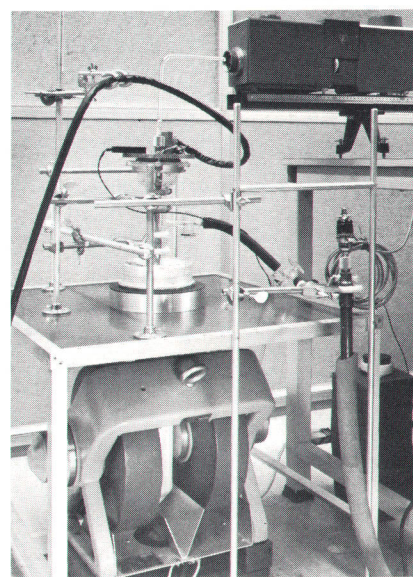

Fig. 3. Samples of materials are placed in a dewar. An electromagnet supplies the necessary magnetic field. Light is piped into the sample holder for photoconductivity and photo-Hall effect measurements.

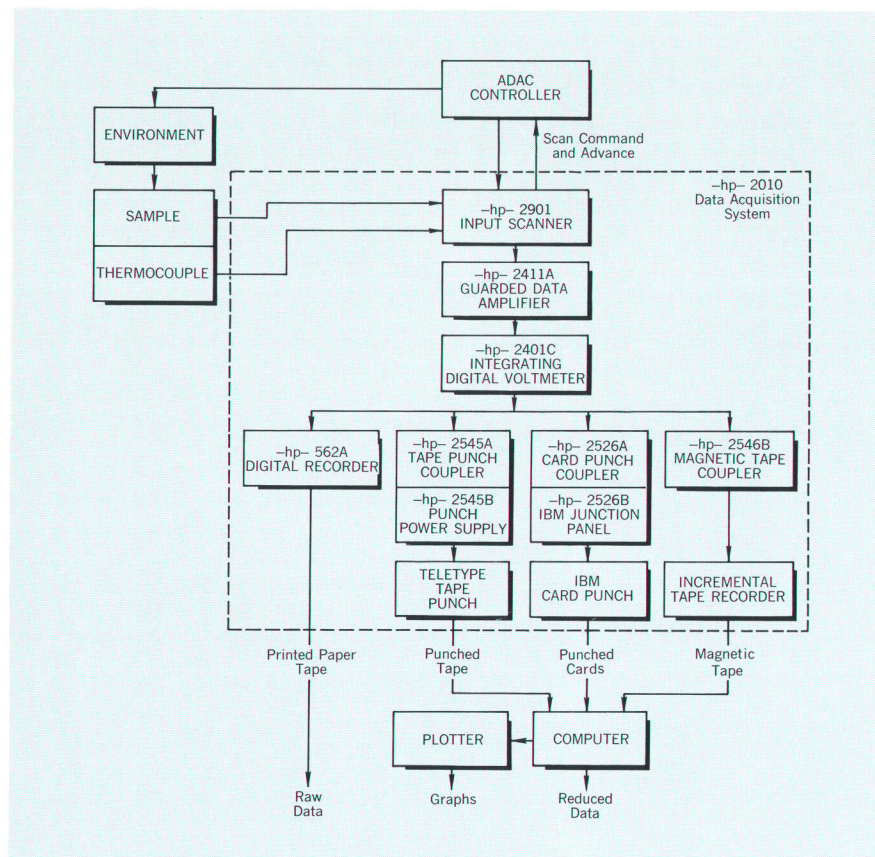

Fig. 4. Environmental parameters and voltage measurements are controlled by the program set in the ADAC Controller. A number of optional arrangements are available for recording the data.

The data acquisition system is composed of an -hp- 2401C Integrating Digital Voltmeter, an -hp- 2411A Guarded Data Amplifier with high input impedance (greater than 10^{10} ohms), an -hp- 2901 Input Scanner and an -hp- 562A printer. The -hp- 2010 system can be modified to give simultaneously printed paper tape and punched IBM cards or printed paper tape and punched paper tape outputs by adding, respectively, an -hp- 2526 or -hp- 2545 coupler and the appropriate punching unit. Alternatively, an -hp- 2546B magnetic tape coupler with the appropriate tape recorder can be added.

An -hp- 2901 Input Scanner connects the measuring instruments to various pairs of voltage probes on the experimental sample as well as

other environment recording detectors including a standard series resistor, thermocouples, photometers, resistance bridges, etc. Samples are held in a dewar between the poles of a magnet (Fig. 3) and the assembly may be cooled to the temperature of liquid nitrogen.

OPERATION

The functional interrelationships of the instruments in the ADAC system are shown in Fig. 4. The block labeled 'environment' represents the magnetic field, electric field, temperature, illumination, etc., to which the experimental sample is exposed. These environmental parameters are controlled by ADAC in a predetermined sequence which is set by its program control matrix and programming switches (Fig. 1). An ex-

ample of the sequence of events is as follows: (1) The interval timer initiates a scan. (2) ADAC sets an environment (turns on the magnetic field, for instance, while maintaining the other parameters constant). (3) ADAC then gives a scan command signal to the input scanner of the -hp- 2010; (4) the -hp- 2010 measures and records voltages between preselected pairs of terminals (up to 25 separate voltages). These voltages are generated both by the experimental sample and by the environment sensors. (5) After -hp- 2010 has completed measuring and recording this set of voltages, it gives a scan advance signal to ADAC which sets another environment. (6) Events 2-5 are repeated until the sample has been subjected to the desired number of environments (9 possible). (7) When ADAC has completed its environment-controlling cycle, it resets the interval timer (which can be set, for example, for intervals from 1 to 30 minutes) and the apparatus is at rest until this timer runs out, at which time another cycle is initiated. (8) After the expiration of the time interval which was set on the Total Acquisition Period timer (up to 30 hours), ADAC turns the entire system off. Because of this automatic mode of operation, it is possible to leave the apparatus unattended to take data overnight or on weekends as the experimental sample slowly warms up from liquid nitrogen temperature to room temperature. The slow rate of temperature change improves the accuracy of the data because the temperature-dependent properties change very little during a data scan.

At the end of an experimental run, the experimental data, in the form of punched cards for example, are processed by computer. If desired, the data can be machine-plotted.

There are extra levels of unused programming capability in the system; these extra levels can be used

to control any desired peripheral apparatus. Without re-programming, the apparatus can be directly used for photo-electromagnetic effect and photovoltaic measurements as a function of temperature. Because the apparatus can be quickly re-programmed for other kinds of measurements, it is a flexible and versatile addition to any laboratory where automated measurements are desirable.

ADVANTAGES

In a period of 5½ months after the

automatic data acquisition system was assembled, a total of 45 overnight and weekend data-runs were completed. The data were reduced and compiled by computer, and in many cases, machine plotted. The experimental samples, Fig. 5, comprise a wide variety of semiconducting materials, some synthesized at *-hp-* Laboratories and some from commercial suppliers.

Labor required in an automated data-run is generally not more than a half day for a technical assistant.

This includes mounting the sample in the sample holder, filling the dewar, checking the electrical contacts to the crystal, and starting the data scan. It also involves a few minutes in preparing data and title cards for the computer format.

The cost of computer and plotter time is about ten dollars per run. The reduced data are usually available the day after taken, and the plots one day later. For comparative purposes, the time and labor necessary for a man to record, reduce, and

TYPICAL ADAC DATA REDUCTION PROCEDURE

In the accompanying equations, the quantities V_j^i are voltages between various pairs of terminals. The subscripts denote the terminal pairs and the superscripts denote the environmental conditions under which the voltages are generated. For example, the voltage V_4^2 is the voltage between terminals T1 and T4 measured in the presence of a magnetic field in the +Z direction and a current in the +X direction. In the process of making a scan, ADAC exposes the sample to permutations and combinations of current and magnetic field, and measures and records the voltages. A computer data

reduction program uses these voltages and other parameters to solve the equations for the quantities σ , μ , and n .

The averaging processes in these equations make full use of the redundancy provided by four potential contacts to remove or minimize (a) thermal voltages, (b) misalignment voltages, (c) current asymmetry due to non-ohmic current contacts, and (d) dimensional and similar experimental errors. Should a sample contain a defective potential contact, then an alternate computational program is used which eliminates the redundancy in the equations.

DEFINITION OF SYMBOLS

- σ = electrical conductivity (ohm-cm)⁻¹
- μ = Hall mobility (cm²/Vs)
- n = carrier density (cm⁻³)
- R = series resistance (between terminals T7 & T8) (ohms)
- e = electronic charge
- W = sample width (dimension in Y direction) (cm)
- t = sample thickness (dimension in Z direction) (cm)
- l_{12} = length of sample between terminals T1 and T2 (cm)
- l_{34} = length of sample between terminals T3 and T4 (cm)
- H = magnetic field in Z direction (G)

$$\sigma = \frac{1}{4RWt} \left[l_{12} \left(\frac{V_6^7}{V_2^7} + \frac{V_6^8}{V_2^8} \right) - l_{34} \left(\frac{V_6^7}{V_3^7} + \frac{V_6^8}{V_3^8} \right) \right]$$

$$\mu = \frac{10^8}{16HW} \left[(V_4^8 + V_5^8) \left(\frac{l_{12}}{V_2^8} - \frac{l_{34}}{V_3^8} \right) + (V_4^9 + V_5^9) \left(\frac{l_{12}}{V_2^9} - \frac{l_{34}}{V_3^9} \right) - (V_4^5 + V_5^5) \left(\frac{l_{12}}{V_2^5} - \frac{l_{34}}{V_3^5} \right) - (V_4^4 + V_5^4) \left(\frac{l_{12}}{V_2^4} - \frac{l_{34}}{V_3^4} \right) \right]$$

$$n = \frac{2HV_6^8V_6^5V_6^9V_6^4}{1.602 \times 10^{-11}Rt} \left[\frac{1}{V_6^5V_6^4(V_5^8V_6^9 + V_5^9V_6^8) - V_6^8V_6^9(V_5^5V_6^4 - V_5^4V_6^5)} + \frac{1}{V_6^5V_6^4(V_4^8V_6^9 + V_4^9V_6^8) - V_6^8V_6^9(V_4^5V_6^4 + V_4^4V_6^5)} \right]$$

Environment (Superscript) Matrix

	-j _x	+j _x
-H _z	5	4
0	6	7
+H _z	9	8

Terminal (Subscript) Matrix

	T2	T3	T4	T8
T1	2		4	
T2		5		
T3			3	
T7				6

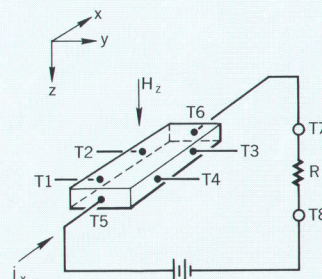

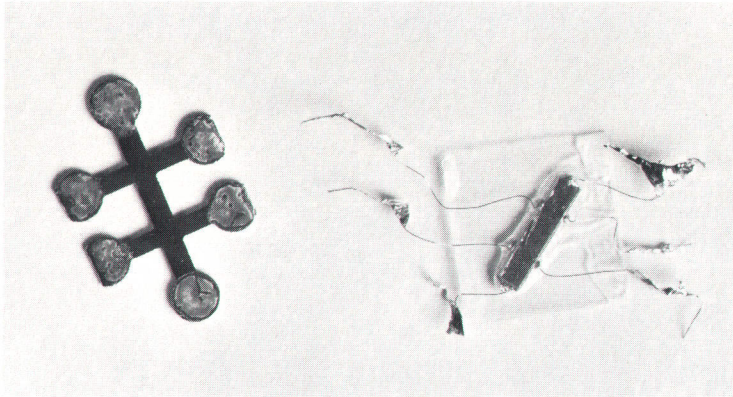

Fig. 5. Standard experimental samples. The dumbbell-shaped specimen, left, is preferred, but smaller pieces of more fragile materials are usually prepared in rectangular bars.

plot the data manually are between one and two man-weeks, depending upon the number of data points required.

ACKNOWLEDGMENT

The authors gratefully acknowl-

edge the assistance of Dr. Lawrence S. Lerner, of our laboratory, who worked out most of the programming dealing with formulas on page 13 and the graph-generating program; and George Boyle of the Dy-

mec Division who provided advice for compatibility and interfacing of ADAC with standard Hewlett-Packard equipment.

The initial stages of this work were carried out while the authors were part of the R & D Laboratory of hp associates.

—Egon Loebner,
T. J. Diesel and
Cristy M. Schade

HEWLETT-PACKARD JOURNAL

TECHNICAL INFORMATION
FROM THE LABORATORIES OF THE
HEWLETT-PACKARD COMPANY

VOL. 18, NO. 3  NOV. 1966

PUBLISHED AT THE CORPORATE OFFICES
1501 PAGE MILL ROAD,
PALO ALTO, CALIFORNIA 94304

Staff: F. J. Burkhard, Editor; R. P. Dolan
H. L. Roberts, L. D. Shergalis

R. A. Erickson, AD

DESIGN LEADERS



T. J. DIESEL

Joe Diesel joined **hp associates** in 1962 and was engaged in studies of new infrared-sensitive photoconducting materials for use in image converters. He is presently in the Solid State Laboratory of the Hewlett-Packard Laboratories. Before joining **—hp—** he worked in the areas of piezoresistive materials and pyroelectric properties of ceramics, and the development of solid state materials.

Joe is a graduate of the University of Colorado. He received his BS degree in Engineering Physics in 1956 and his MS degree in Physics in 1960. He is a member of the American Physical Society, IEEE, American Institute of Physics, and Sigma Pi Sigma.

Egon Loebner joined **hp associates** in 1961 as manager of optoelectronics. Here he headed research on solid-state

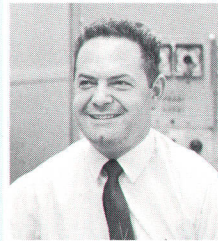

EGON E. LOEBNER

displays, optoelectronic networks and image converters. He contributed to the phenomena of p-n injection electroluminescence in gallium arsenide, boron phosphide and GaAs-GaP alloys. Recently he worked with high-gain photoconductivity in counterdoped silicon and its utilization.

Dr. Loebner holds a degree in Mechanical Engineering from the Higher Industrial Institute in Plzeň, Czechoslovakia, and BA and PhD degrees in Physics from the University of Buffalo. Prior to joining Hewlett-Packard, he was with RCA Laboratories. Dr. Loebner has contributed widely to the professional and technical literature, holds several patents, and has served on boards and committees of numerous societies, publications and governmental bodies.



CRISTY M. SCHADE

Cris Schade, a student engineer, joined **—hp—** in 1965. His first assignment was to design and construct a fully-programmable, Hall effect Automatic Data Acquisition Controller (ADAC). He also worked on the characterization of optoelectronic devices including two-element photon amplifiers.

Cris returned to **—hp—** Laboratories in 1966 after additional study at the University of California at Berkeley and is now doing optoelectronic device characterization for special applications, including a noise-measuring system. He has made an original contribution for which a patent is pending.

Cris is in his fourth year at Berkeley and is working for **—hp—** under the Cooperative Work-Study Program sponsored by the College of Engineering. He is a member of Tau Beta Pi.

INDIUM ARSENIDE STUDY

(cont'd from back cover)

InAs. Fig. 1(a) shows a computer-generated plot of conductivity and carrier concentration on logarithmic scales vs. inverse absolute temperature, of an undoped InAs sample from Monsanto ingot C2 494. The upper curve represents the conductivity, which decreases from 26 mho/cm at 295°K to 28 mho/cm at 80°K. The lower curve indicates the change in free electron concentration over the same range. This drops from $2.1 \times 10^{16}/\text{cm}^3$ to $1.1 \times 10^{16}/\text{cm}^3$.

Fig. 1(b) is the computer-generated graph of the calculated mobility vs. absolute temperature, both on logarithmic scales. These plots are useful to determine activation energies directly from

the slopes of graph 1(a) or scattering mechanisms from the slopes of 1(b). The mobility is nearly constant having a value of about 15,000 cm^2/Vs with a slight maximum at about 140°K.

Figs. 1(c) and 1(d) are plots identical to those seen in Figs. 1(a) and 1(b) except that the InAs material has undergone a diffusion with gold. (There are no previous reports of such a treatment in the literature.) In Fig. 1(c), the lower curve is the conductivity curve. While a pronounced change has taken place in the conductivity and mobility, as shown in Fig. 1(d), only a small modification in the free electron concentration has taken place. Note that the temperature plots, because of curvatures and inflection points, contain much more information about the samples than can be obtained from measure-

ments at just one or two temperatures.

While the study of n-type InAs is still in its beginning, the initial results appear consistent with the earlier reports of the conductivity anomaly. The origin of the observed mobility decrease resulting from gold diffusion has not yet been uniquely determined, but examination of the material will be made for evidence of gold precipitates and other possible causes of increased electron scattering. It is hoped that the great flexibility in programming of data acquisition offered by ADAC, combined with computerized data reduction and plotting will enable tackling and solving problems which otherwise would be too time-consuming.

The sample preparations and gold diffusions were carried out by Dzidra Samsonovs of the -hp- Laboratories.

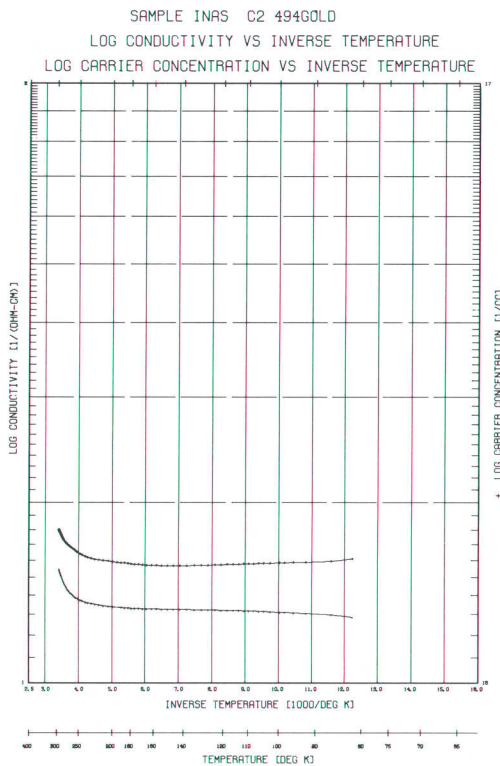

Figure 1(c)

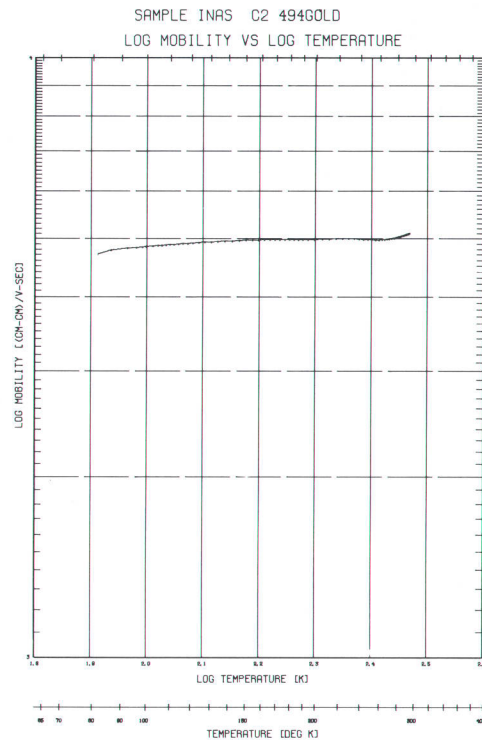

Figure 1(d)

A STUDY OF INDIUM ARSENIDE USING ADAC EQUIPMENT

Among the III-V semiconducting intermetallic compounds InAs and GaSb present in their undoped state a most anomalous conductivity behavior. The conductivity of undoped InAs is always n-type and its electron concentration, in spite of numerous purification attempts, has not been reduced significantly below $10^{16}/\text{cm}^3$. The conductivity of undoped GaSb is always p-type and its hole concentration, in spite of experiments on purification and partial pressure of constituents, is always in excess

of $10^{17}/\text{cm}^3$. There have been suggestions that these rather large deviations and anomalies are not due to impurities but are caused by deviations from stoichiometry and such defects as vacancies or antistructure defects (a Ga atom on an Sb site in GaSb and an As atom on an In site in InAs). It is also interesting to note that the corresponding II-VI compounds ZnTe and CdSe suffer from a similar inadequacy, but more so. ZnTe cannot be synthesized n-type and CdSe cannot be synthesized p-type irrespec-

tive of even the most strenuous attempts to dope them. Thus, an examination of the problem in InAs may not only help improve that material and make it available for device exploitation but may also shed additional light on the old problem of "compensation" and dopability of II-VI compounds.

The curves in Figs. 1(a) - 1(d), obtained with the ADAC equipment, are part of a study to gain new insight into the electronic transport properties of
(continued inside on page 15)

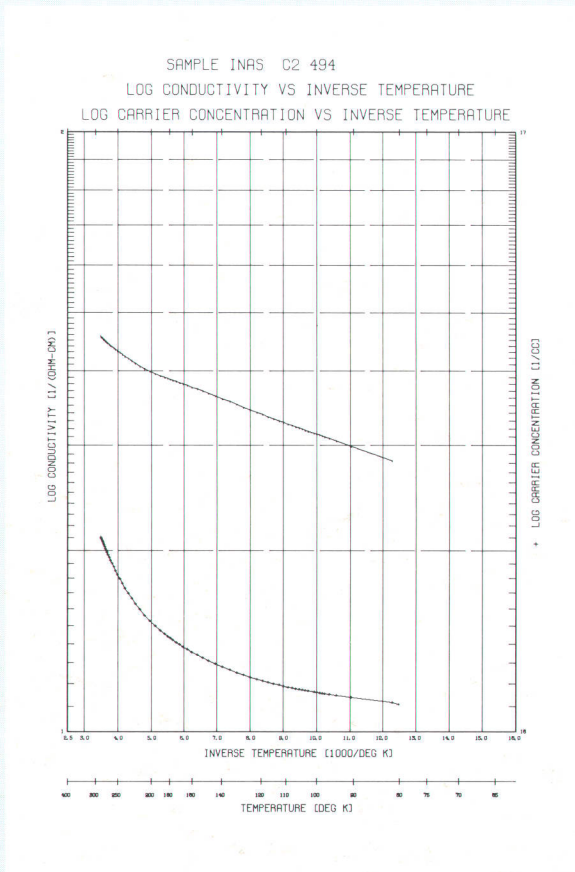

Figure 1(a)

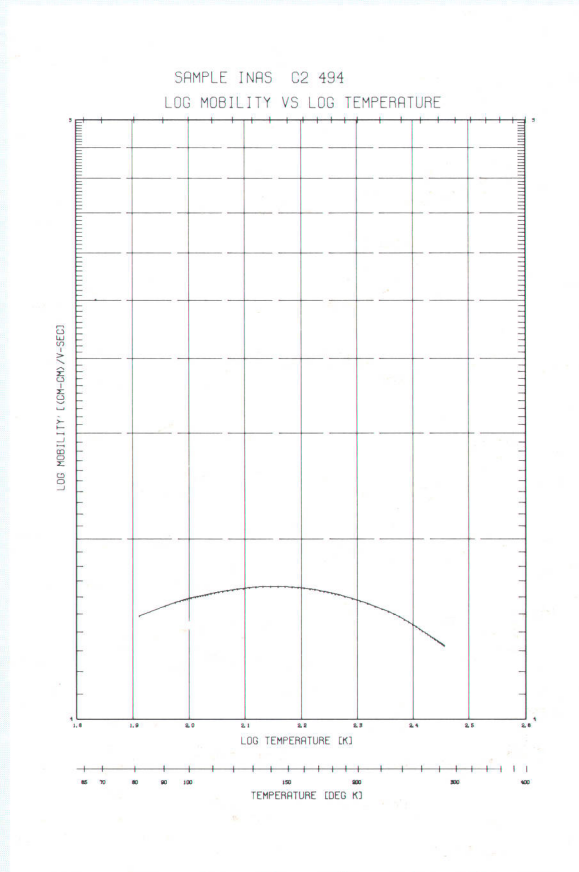

Figure 1(b)